

2.1 Angles

Find the measure of each angle.

1)

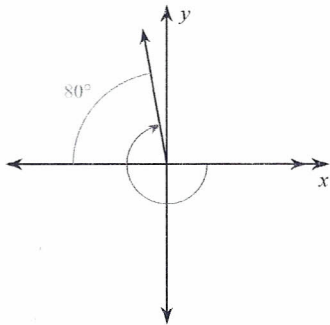

2)

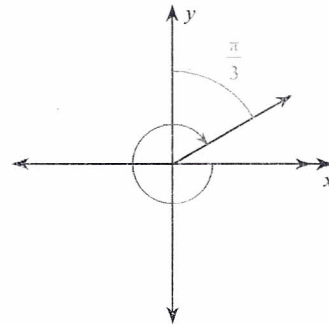

3)

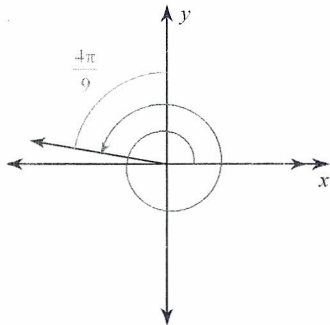

4)

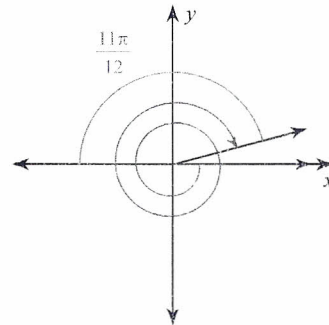

5)

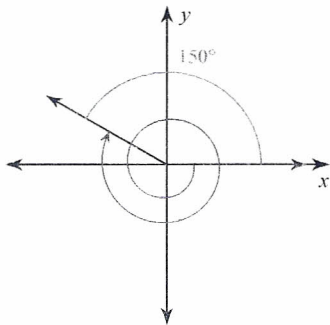

6)

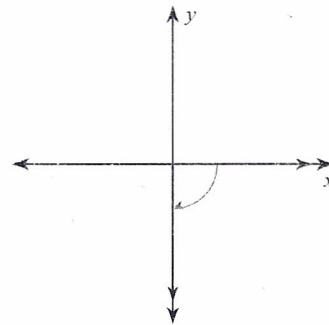

Find the reference angle.

7)

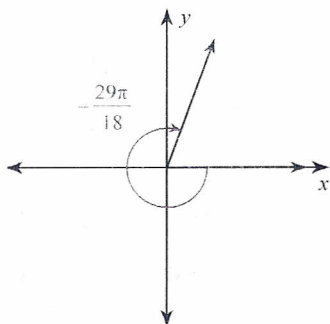

8)

